

Summary of the last ISS meeting + NuFact06

<http://nufact06.physics.uci.edu/>

- April 2005 John Wood – CEO CCLRC(RAL) – proposes a one year ‘Scoping Study’ for a future **neutrino factory**
- May 2005 Meeting in London to start the process Committee – **S Geer, Y Kuno, V Palladino, K Peach** charged with setting up the organisation
- ISS launched at NuFact05 in Frascati - to conclude at NuFact06
- The brief was broadened to include future **superbeams** in addition to the neutrino factory
- The study became truly international
 - Support from NFMCC in the US, Nufact-J in Japan, BENE in Europe
 - Equal sharing of positions between Europe, Japan and the USA
 - Meetings take place in all three areas
- Results to be relevant for the whole community not just one lab.

To set baselines for a design study leading to a conceptual design

- Significant *international* effort taking several years
- Requires successful bids to provide the resources

- **Review options for accelerator complex:**
 - Prepare concept-development and hardware-R&D roadmaps for design-study phase

- **Review options for neutrino-detection systems**
 - Emphasis: identify concept-development and hardware-R&D roadmaps for design-study phase

- **Review physics case**
 - ⇒ The case for an advanced neutrino oscillation facility
 - ⇒ Critical comparison of options

Scoping study for a future neutrino complex *organisational chart*

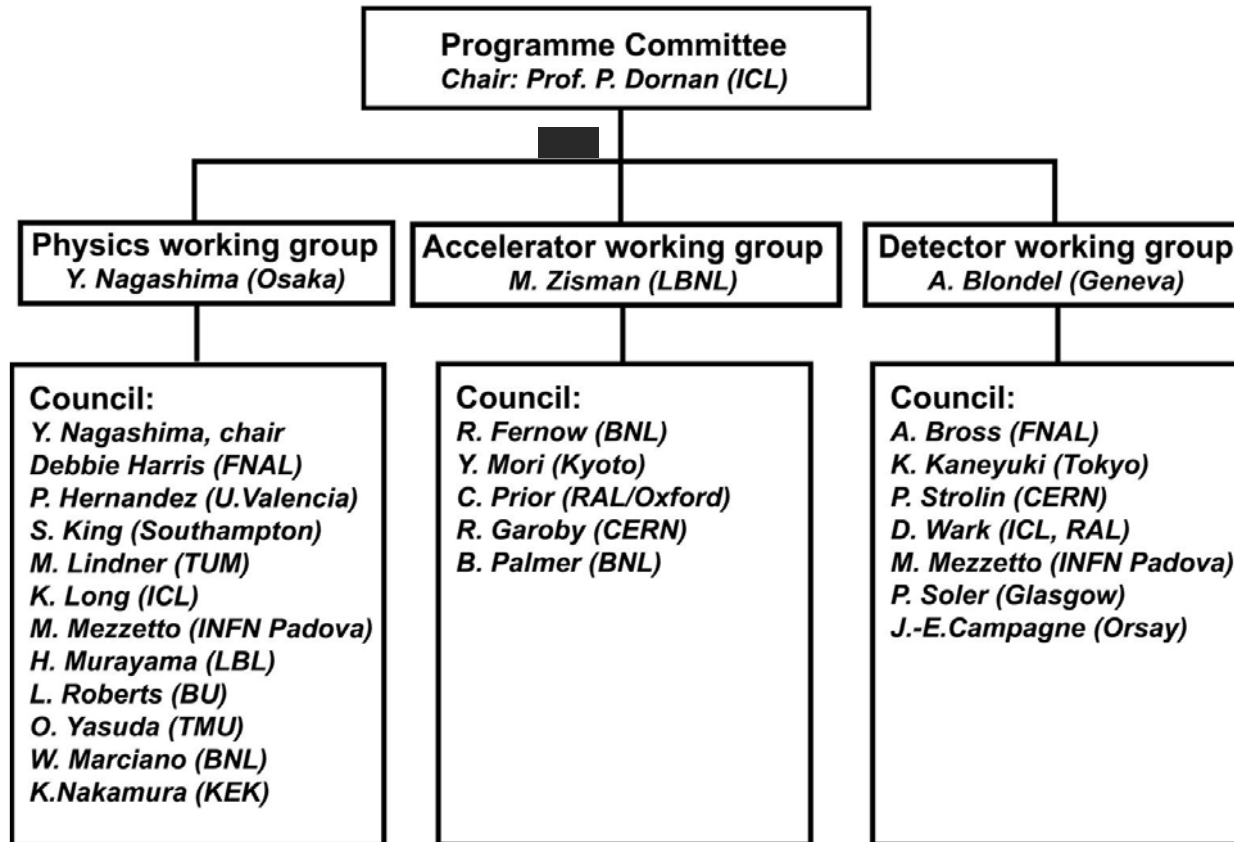

- **Plenary meetings to date:**
 - **CERN: 22 – 24 September 2005**
 - Attendance: 90
 - **KEK: 23 – 26 January 2006**
 - Attendance: 70
 - **RAL: 24 – 29 April 2006**
 - Attendance: 80
 - **Irvine: 21 – 23 August 2006**
 - Attendance: 70

- **Working groups:**
 - **Physics:**
 - Workshops: Imperial: 14 – 21 November 2005
 - Boston: 6 – 10 March 2006
 - Valencia: 3 – 6 July 2006
 - **Accelerator:**
 - Workshops: BNL: 07 – 12 December 2005
 - Princeton: 26 – 28 July 2006
 - **Detector:**
 - Workshops CERN: 3 – 5 July 2006
 - Detector/Physics parallel at Physics workshops

- Last ISS Plenary meeting held this week
- Next three talks will summarise the output of the year's study
 - Physics - Ken Long
 - Accelerator - Mike Zisman
 - Detector - Malcolm Ellis

To follow

ISS Final Report

By the end of the year

Essentially the results from today but there will be more harmonisation between the groups

A New Collaborative Effort to build on the outcome of the ISS for an
International Design Study for a Neutrino Factory
to be discussed next Wednesday

Conclusions of Physics WG (K. Long):

- Compelling case for precision neutrino programme
 - Develop and evaluate methods to discriminate between theories describing the Physics of Flavour
 - Evaluate contribution a muon-physics programme can make
- Extensive performance evaluation of super-beam, beta-beam, and Neutrino Factory options:
 - Large θ_{13} : $\sin^2 2\theta_{13} > 10^{-2}$
 - Comparable sensitivity
 - \Rightarrow need to include cost and schedule considerations in evaluating optimum
 - Intermediate θ_{13} : $5 \times 10^{-4} < \sin^2 2\theta_{13} < 10^{-2}$
 - Neutrino Factory better, beta beam competitive
 - \Rightarrow need to include cost and schedule considerations in evaluating optimum
 - Low θ_{13} : $\sin^2 2\theta_{13} < 5 \times 10^{-4}$
 - With present assumptions Neutrino Factory out-performs other options
 - \Rightarrow need to include cost and schedule considerations in evaluating optimum

Clear motivation to move from ISS phase to full
'Design Study' phase

Conclusions of Detector WG (M. Ellis) 1/2:

- For low energy beams, the **Water Cherenkov** can be considered as a baseline detector technology at least below pion threshold. An active international activity exists in this domain. 1Mton $\sim(0.5-1)$ G€
- For medium energy (few GeV) there is competition and it is not obvious which detector (WC, LArg or TAsD) gives the best performance at a given cost.
- For the neutrino factory a 100 kton magnetized iron detector can be built at a cost of 200~300 M\$ for the golden channel.
- A non magnetic Emulsion Cloud Chamber (ECC) detector for tau detection can be added with a mass of ~ 5 kton
- There is interest/hope that low Z detectors can be embedded in a **Large Magnetic Volume**. At first sight difficulties and cost may be large. This should be actively pursued.
- Electron sign determination up to 10 GeV has been demonstrated for MECC, and studies are ongoing for Liquid Argon and pure scintillator detector.

Conclusions of Detector WG (M. Ellis) 2/2:

- Near detector, beam instrumentation and cross-section measurements are absolutely required.
- The precision measurements such as CP violation constitute a new game with respect to the present generation
- For the super-beam and beta beam the near detector and beam diagnostic systems need to be invented.
- There is a serious potential problem at low energy due to the interplay of muon mass effect and nuclear effects. A first evaluation was made at the occasion of the study.
- NUFACT flux and cross sections should be calibrated with a precision of 10^{-3} . An important design and simulation effort is required for the near detector and diagnostic area. (Shielding strategy is unknown at this point)
- Finally, matter effects were discussed with the conclusion that a systematic error at 2% seems achievable with good collaboration with geologists.

Conclusions of Machine WG (M. Zismann) 1/4

Decision on baseline:

- Proton Driver
 - specify parameters, not design
 - implicitly assumes liquid-metal target

<u>Parameter</u>	<u>Value</u>
Energy (GeV)	10 ± 5
Beam power (MW)	4
Repetition rate (Hz)	≈ 50
No. of bunch trains	3,5 ^{a)}
Bunch length, rms (ns)	2 ± 1
Beam duration ^{b)} (μs)	≈ 40

- ^{a)} Values ranging from 1-5 possibly acceptable.
^{b)} Maximum spill duration for liquid-metal target.

Decision on baseline

- **Target**
 - assume Hg target; look at Pb-Bi also

- **Front End**
 - **bunching and phase rotation**
 - use U.S. Study 2a configuration
 - **cooling**
 - include in baseline; use U.S. Study 2a configuration
 - **keep both signs of muons**
 - “waste not, want not”

Decision on baseline

- **Acceleration**
 - used mixed system
 - linac, dog-bone RLA(s), FFAGs
 - transition energies between subsystems still being debated

- **Decay Ring**
 - adopt racetrack
 - keep alive triangle as alternative
 - depends on choice of source and baselines
 - energy 20 to 40 GeV
 - 50 GeV okay for ring, but implies more acceleration than presently planned

Next phase

- **Focus on selected option(s)**
 - as part of upcoming International Design Study
 - IDS will eventually have more of an engineering aspect than the ISS

- **Making final choices requires (“top-down”) cost evaluation**
 - **requires engineering resources knowledgeable in accelerator and detector design**

- **Organize R&D efforts in support of facility design**
 - requires international coordination
 - happening now via NuFact Workshops and informal contacts

NuFact06 – main facts

- Strong CERN participation (report by CNGS team + significant representation of the CERN beta-beam team)
- Weak Japanese participation (pressure of the JPARC project)
- Very active Machine Working Group:

TOPICS	~ TIME	Nb. of TALKS
Super-beams & conventional beams (+ focus session)	Friday a.m.	4
Targets (+ focus session)	Friday p.m.	4
Beta-beams	Sunday a.m.	4
Proton drivers & HARP results	Sunday p.m.	6
FFAG's	Monday a.m.	4
Collection systems	Monday p.m.	7
Acceleration	Tuesday a.m.	7
Cooling	Tuesday p.m.	6
Storage rings	Tuesday p.m.	3
Total		45

Proton drivers

The JPARC accelerator complex (1/2)– Y. Yamazaki

- JPARC will soon enter in the beam commissioning phase

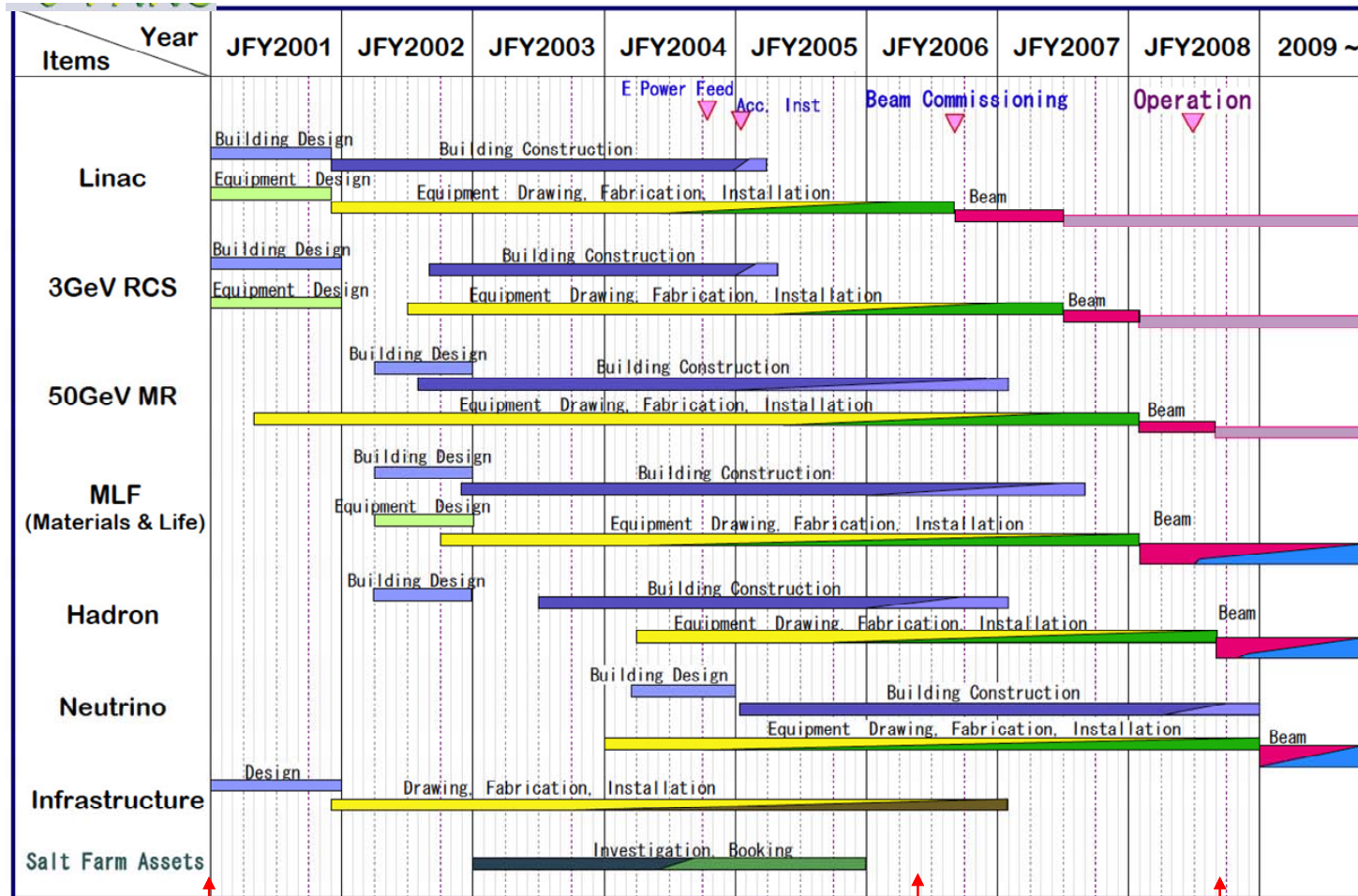

The JPARC accelerator complex (2/2)– Y. Yamazaki

- Main problems of today: reduced linac energy (180 instead of 400 MeV) and difficulties with the production of the RF cavities for the synchrotrons (better news recently...)

Final Goal (Phase II)

- **MR: 0.75 MW** (50 GeV, 15 μ A)
- **RCS: 1 MW** (3 GeV, <1 μ s, ~ 25 Hz) for spallation neutron source

Phase I Goal

- **MR: 0.6 MW** (40 GeV, 15 μ A)
- **RCS: 1 MW** (3 GeV, 333 μ A)

Phase I₀ Goal

- **MR: 0.36 MW** (40 GeV, 9 μ A)
- **RCS: 0.6 MW** (3 GeV, 200 μ A)
- Various operational modes have been proposed to increase the beam power, like increasing the number of MR bunches and/or the MR repetition rate. For the time-being, the main goal is to reach Phase I₀ Goal with robust / reliable hardware.

Proton drivers

SPL-based 5 GeV proton driver – R. Garoby

- 3.5 GeV SPL CDR-2 published [CERN-2006-006]
- Proposal for a 5 GeV version (CDR-3) with accumulator/compressor meeting the ISS requirement.

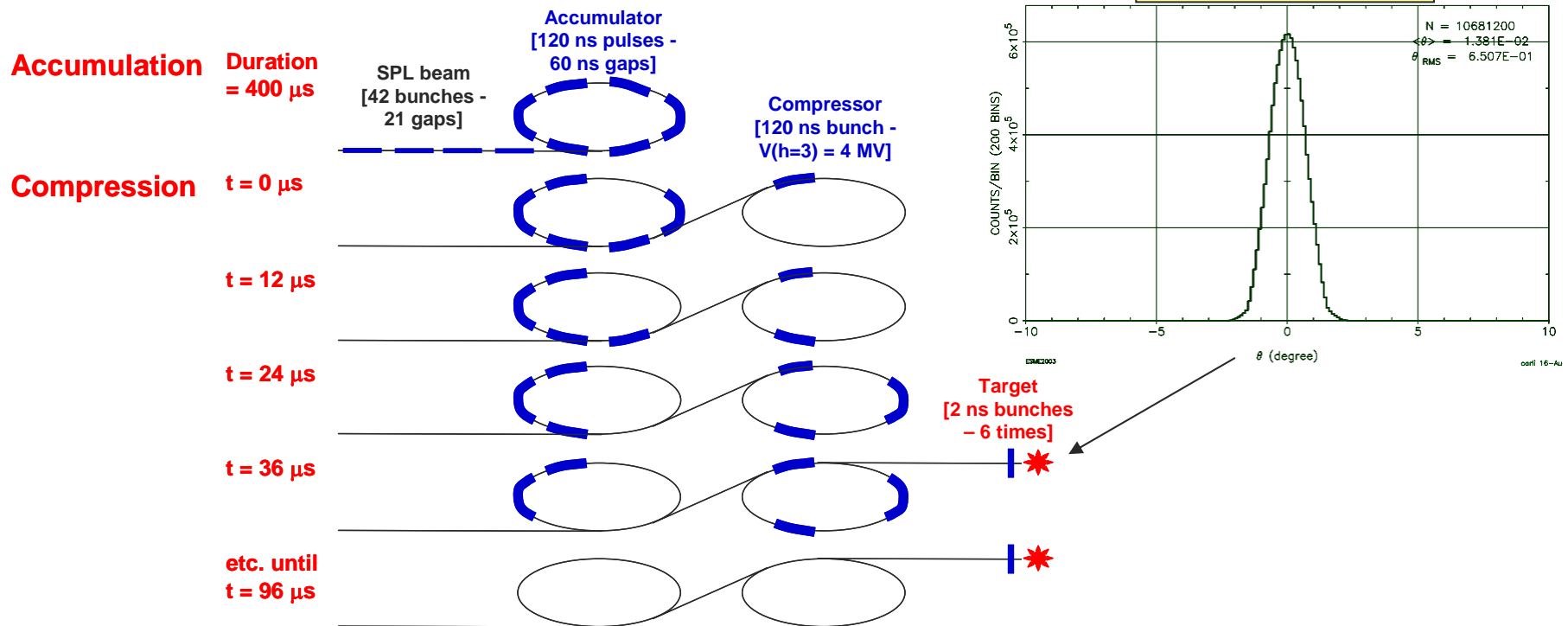

Measurement of the production of charged pions by low energy protons – S. Borghi

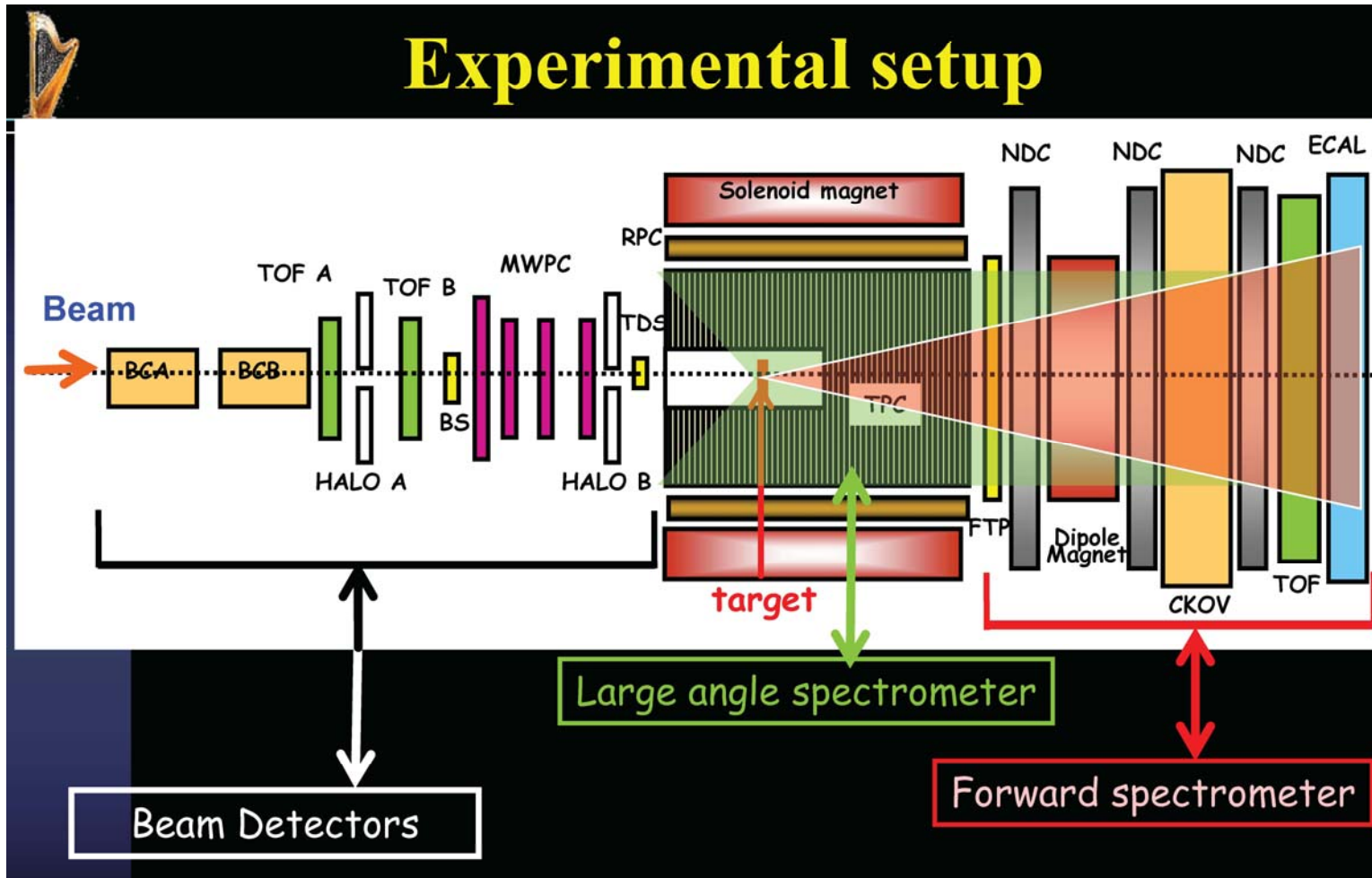

 Preliminary	Systematic errors		0.35 θ <math>< 0.95</math> rad 100-300 300-500	
	Error Source	δ_{diff} (%)	δ_{diff} (%)	
	Global efficiency	1.5	1.7	1.0
	Absorption	0.6	1.8	0.4
	Tertiary particles	3.1	4.3	2.4
	Electron subtraction	5.7	2.1	1.1
	PID migration	3.8	4.1	1.6
	Momentum resolution	5.4	1.4	0.5
	Momentum scale	3.6	4.2	2.8
	Theta scale	1.4	0.8	0.1
	Total systematic	12.5	8.2	4.7
	Statistical error	8.7	2.6	2.3

HARP results (3/4)

Total pions yield on a Tantalum target

Integration limits:

$$100 < p < 700 \text{ MeV}$$

$$0.35 < \theta < 1.55 \text{ rad}$$

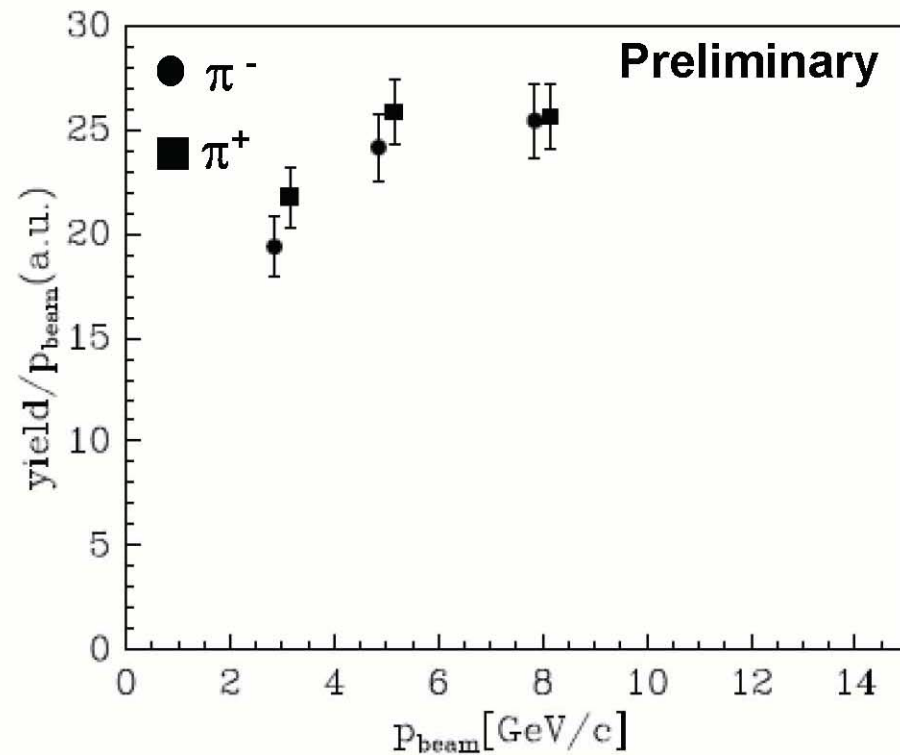
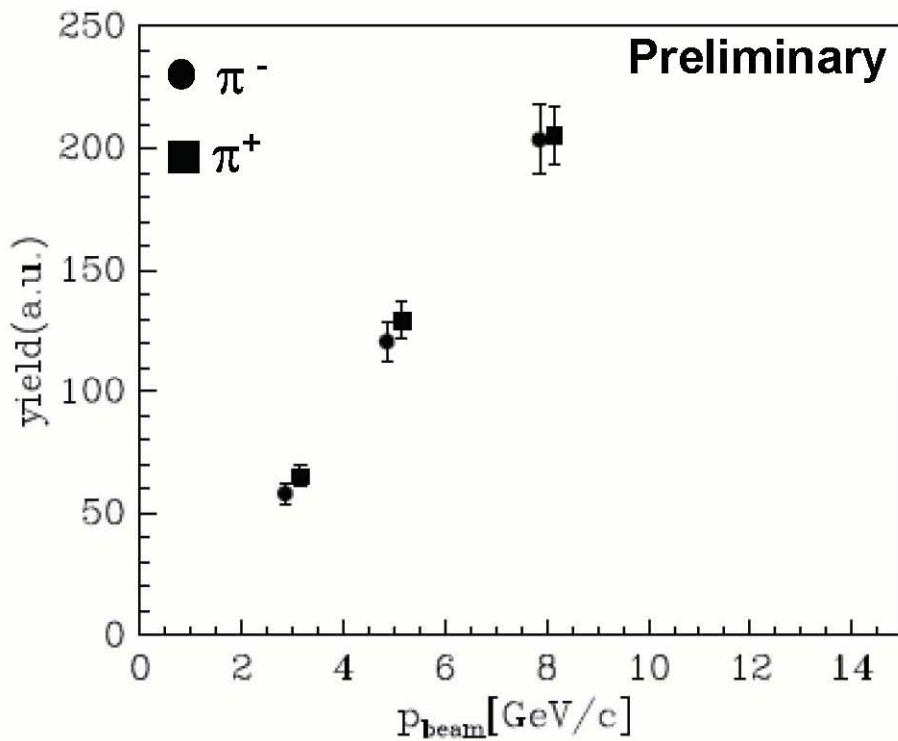



Conclusions

- Advanced 2 analysis for pTa(5% λ_1) at 5 GeV/c for differential cross section of pions production in the large angle region ($0.35 \text{ rad} \leq \theta \leq 2.15 \text{ rad}$)
- Preliminary results at 3 and 8 GeV/c
⇒ soon also the data at 12 GeV/c

PAPER IN PREPARATION

- In progress analysis with other target as:
Pb, C, Sn, Cu, Al

**Harp ready to provide all data needed
for the optimization of NuFact.**

Collection systems

G4Beamline – T. Roberts

- G4Beamline is a simulation program capable of accurate and realistic simulations via single-particle tracking.
- It has an intuitive, user-friendly interface that reflects the complexity of the problem, and is directly readable by physicists familiar with the problem domain.
- Simulations of complex accelerator systems can be performed without C++ programming.

<http://g4beamline.muonsinc.com>

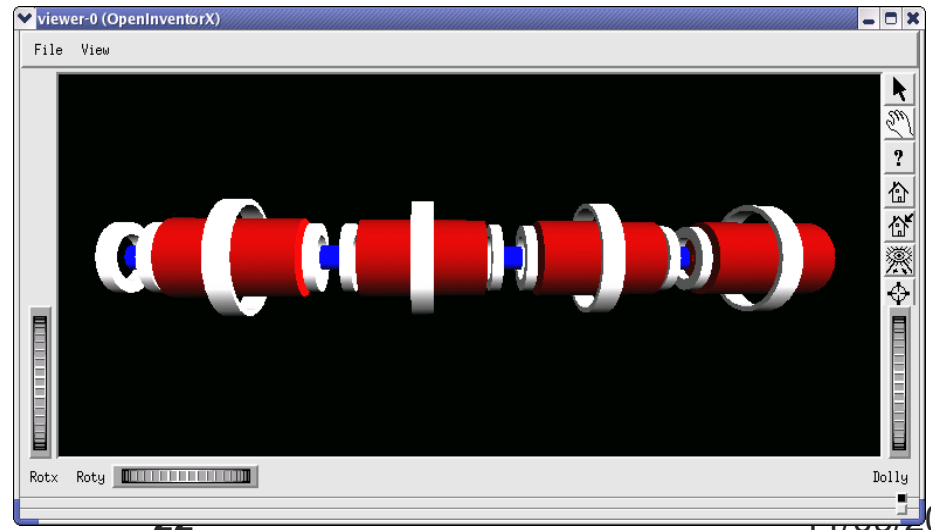
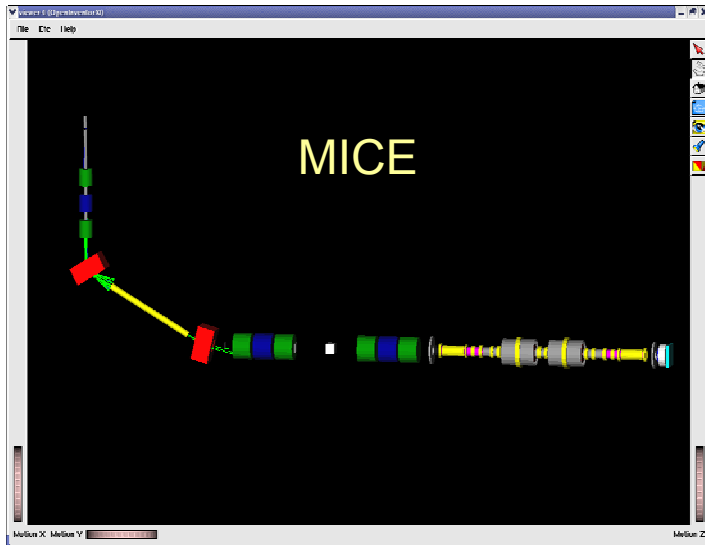

Acceleration

Muon acceleration systems – S. Machida

End to end simulation – Evolution of emittance and beam loss

- Initial parameters
 - 0.07%, 0.20/ β *2pi
 - 30 pi mm
 - Waterbag distribution

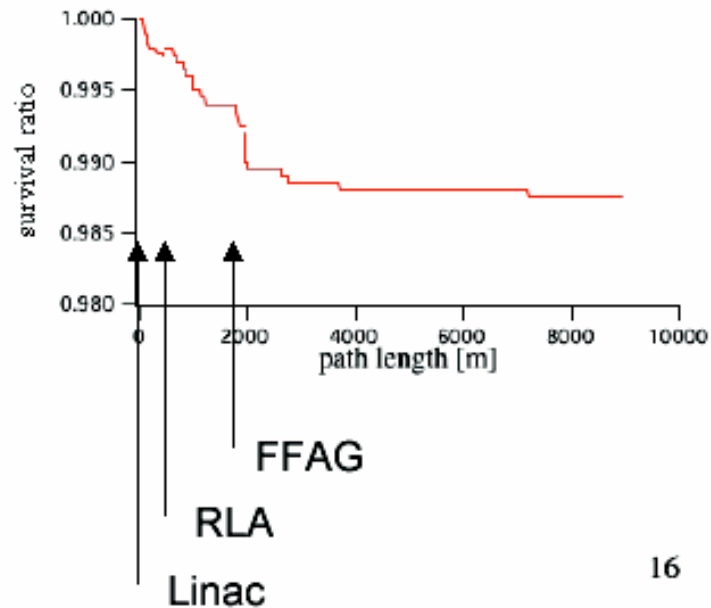
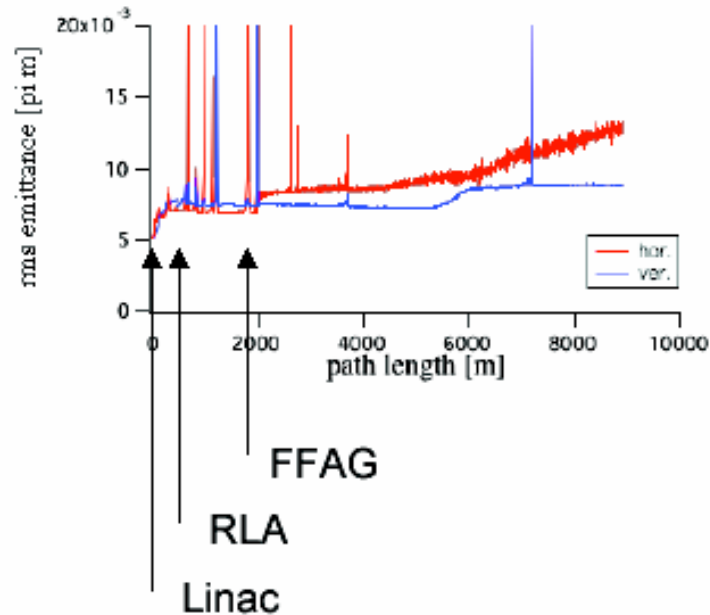

Acceleration

Dogbone RLA – A. Bogacz

Conservative proposal : 12.5 GeV cascaded dogbone RLAs – 3.5 pass
Energy ratio (per RLA) $E_f/E_0=2.5$

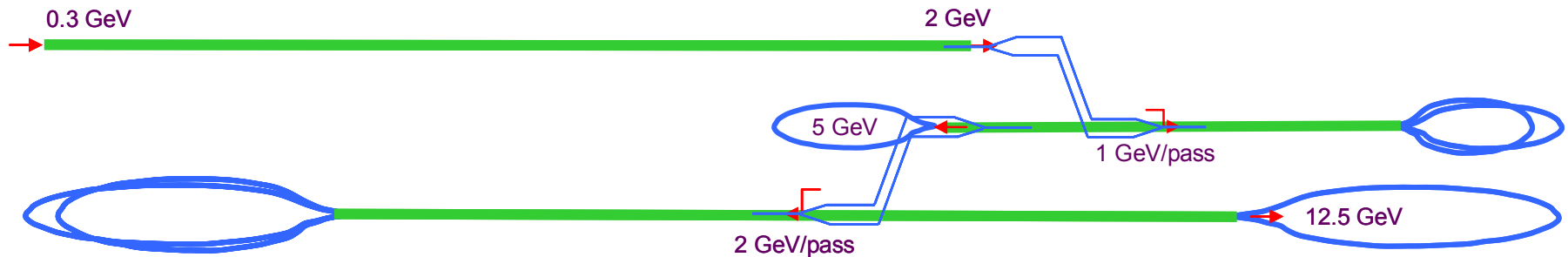

Aggressive proposal: 15 GeV dogbone RLA (FODO lattice) – 6.5 pass
Energy ratio $E_f/E_0=7.5$!

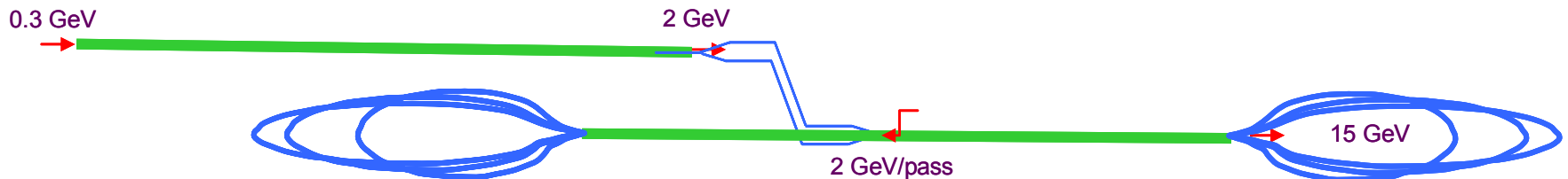

A scheme for a muon collider (1/2) – R. Palmer

Acceleration using the ILC

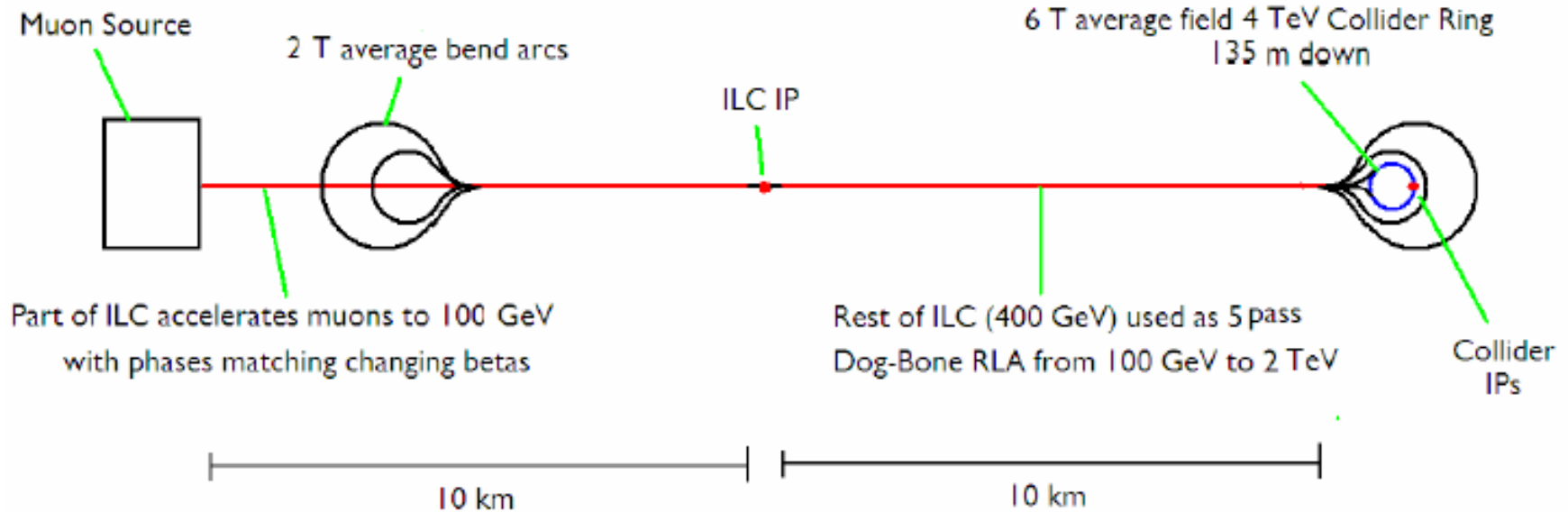

- 4 TeV design assumes 500 TeV ILC gradients (30 MV/m)
- Decay losses from 1 GeV to 2 TeV only 8 %
- 8 TeV design will depend on nature of 1 TeV ILC upgrade
- If no ILC, then RLA to 1 TeV, then pulsed synchrotron (Summers)

A scheme for a muon collider (2/2) – R. Palmer

Muon survival (first guess)

	Transmission	Cumulative
21 vs 54 bunches	.7	.7
Pre-merge RFOFO cooling	≈ .5	.35
Merging	0.8	0.28
Post-merge RFOFO cooling	≈ 0.5	0.14
Final 50 T solenoid cooling	.7	0.1
Acceleration to 2 TeV	0.7	0.07

Required Muons per bunch	$2 \cdot 10^{12}$
Muons per bunch after merge	$8 \cdot 10^{12}$
Initial Muons per bunch	$2.8 \cdot 10^{13}$
Initial muons per 24 GeV proton	0.4
Initial 24 GeV protons	$7 \cdot 10^{13}$
Proton power for 4 TeV (MW)	1.5
Proton power for 8 TeV (MW)	0.8

- Proton power < ISS Neutrino Factory
- But lower rep rate → more charge/bunch
Need $E > 8$ GeV to get 1-3 ns proton bunch of $7 \cdot 10^{13}$
- Loading with $8 \cdot 10^{12}$ muons per bunch needs study

A shared sc linac for protons and muons (1/2) – R. Johnson

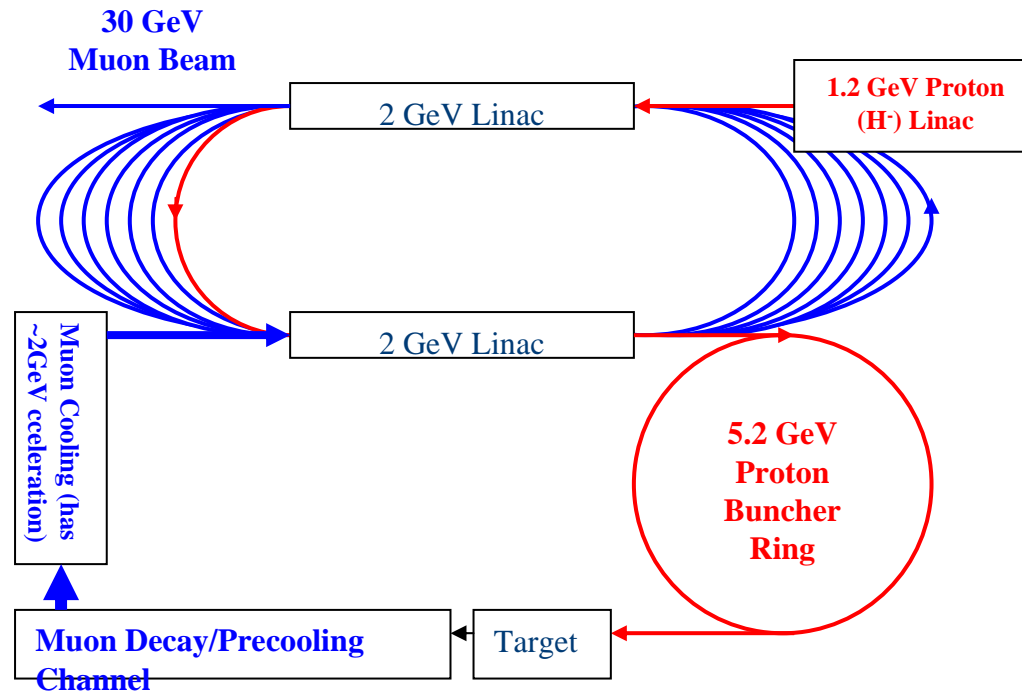

- Advances in muon cooling imply that a muon beam can be accelerated in high-frequency SC RF. A Greenfield neutrino factory can use this capability so the proton driver and muon RLA share the same Linacs. The beam can be used by either a NF (with smaller emittance storage ring) or an MC (with a muon coalescing ring). High intensity comes by increasing the rep rate.
- Several new muon cooling projects were reviewed, including a 6D experiment for Fermilab.